

Nov 2019

Trade Show News: The NAMM 2020 in California

Winstar Display will present a wide range of display technology highlights on its booth No.1027 at the NAMM Show in California. This Trade Show will be held from January 16 to 19, 2020 in Anaheim, CA. Winstar has 21+ years of manufacturing and R&D experiences in providing stunning visual display solutions. Discuss your user experience needs or about your coming projects with one of our display engineers at our booth. Welcome to learn more about our solutions.

The NAMM Show 2020

- ▶ Date : January 16~18, 2020 (10AM~6PM) to January 19, 2020 (10AM~5PM)
- ▶ Location : Anaheim Convention Center, Anaheim, CA
- ▶ Booth No. #1027
- ▶ <https://www.namm.org/thenammshow/2020/directory/winstar-display>



WINSTAR Interactive Display Solution Provider
Winstar Display

Display Solution

TFT

OLED

STN

Booth 1027

The NAMM Show
January 16/19 2020 california

January 16-18 10 am-6 pm
January 19 10 am-5 pm

Anaheim Convention Center, Anaheim, CA

0.96" OLED WEO012864C with ZIF FPC Version

WEO012864C-ZIF is a ZIF FPC version of Graphic OLED WEO012864C model. This OLED display is made of 128x64 pixels, diagonal size only 0.96 inch. The WEO012864C-ZIF version is built in with SH1106G controller IC and it communicates via 6800/8080 8-bit parallel, I2C and 4-wire SPI interface, 1/64 duty cycle.

WEO012864C-ZIF is a small COG OLED display which is very thin; lightweight and low power consumption. It is suitable for handheld instruments, smart meters, voice recorder, wearable device, IoT, etc. WEO012864C-ZIF module can be operating at temperatures from -40°C to +80°C; its storage temperatures range from -40°C to +85°C.

WEO012864C-ZIF	Dimension
Dot Matrix	128 x 64
Module dimension	26.70 × 19.26 × 1.26 mm
Active Area	21.74 × 10.86 mm
Pixel Size	0.148 × 0.148 mm
Pixel Pitch	0.170 × 0.170 mm
Display Mode	Passive Matrix
Display Color	White / Yellow
Drive Duty	1/64 Duty
Controller IC	SH1106G
Interface	6800, 8080, SPI, I2C
Size	0.96 inch

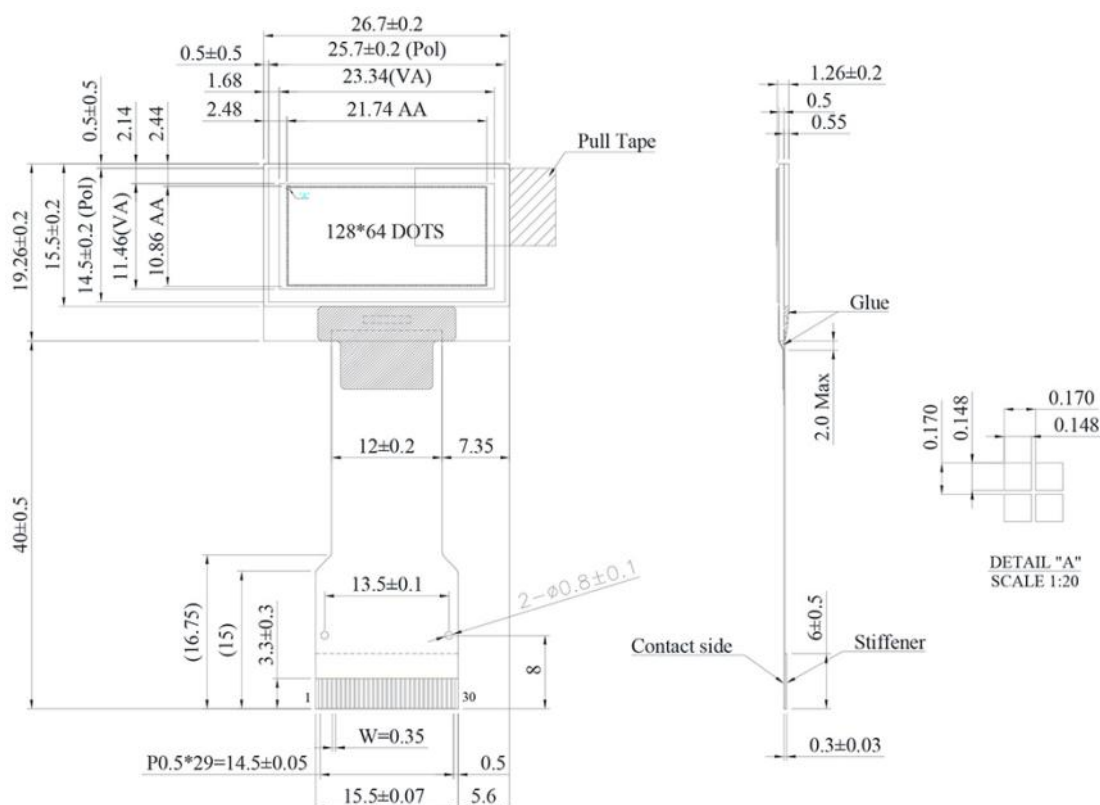



2.08" COG OLED WEO025664A with ZIF FPC Version

WEO025664A-ZIF is a graphic OLED display COG (chip on glass) type which is made of 256x64 pixels, diagonal size 2.08 inch. WEO025664A is built in with SSD1362 driver IC; it can communicate via 6800/8080 8-bit parallel, I2C, 3-Wire and 4-Wire SPI interface; it supports 4 bits grayscale image. The supply voltage for logic of WEO025664A is 3V supply, 1/64 duty cycle, display with 50% check board current is 15mA@ 12Vcc (typical value). This OLED module can be operating at temperatures from -40°C to +80°C; its storage temperatures range from -40°C to +85°C.

WEO025664A-ZIF is a COG structure OLED module which is ultra thin 1.61 mm; lightweight and low power consumption. It is suitable for smart home application, meter device, personal care appliance, health device, etc.

WEO025664A-ZIF	Dimension
Dot Matrix	256 x 64 Dots
Module dimension	60.5 x 19.0 x 1.61 mm
Active Area	51.18 x 12.78 mm
Pixel Size	0.18 x 0.18 mm
Pixel Pitch	0.2 x 0.2 mm
Display Mode	Passive Matrix
Display Color	White/Yellow
Drive Duty	1/64 Duty
Gray Scale	4 Bits
IC	SSD1362
Interface	3-Wire and 4-Wire SPI,I2C,6800,8080
Size	2.08 inch

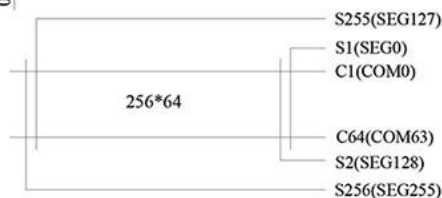
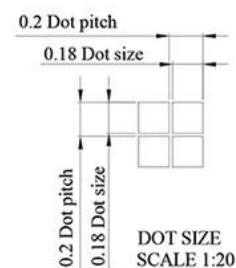
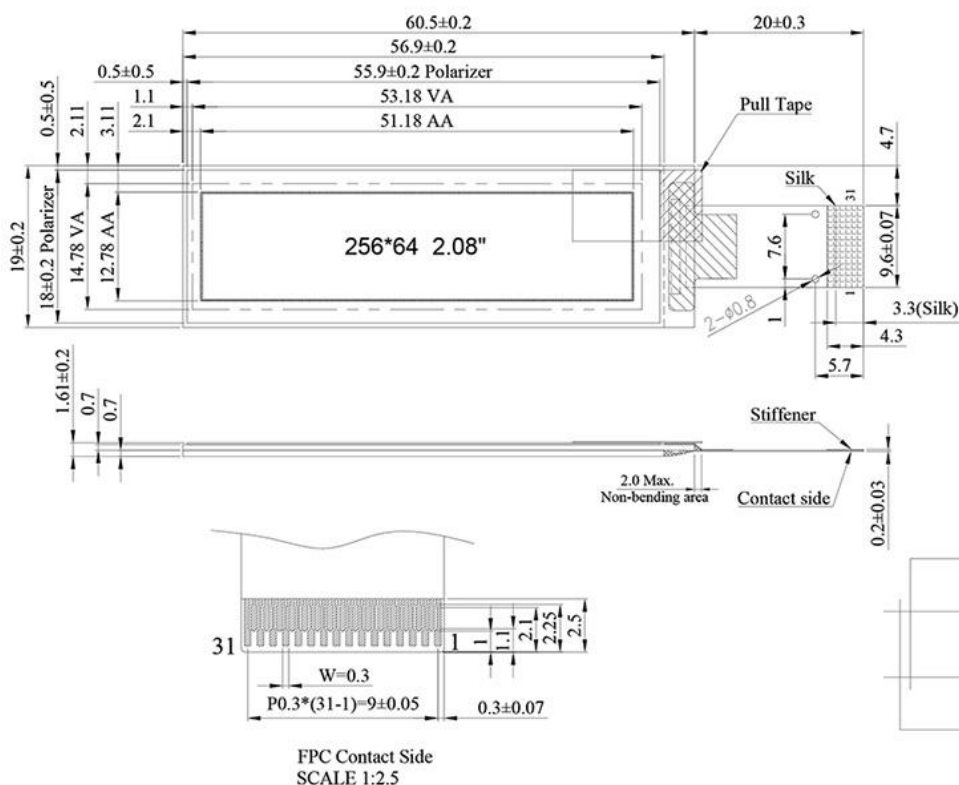

2.08" COG OLED WEO025664A with Hotbar Version

WEO025664A-Hotbar soldering version is a graphic COG OLED display which is made of 256x64 pixels, diagonal size 2.08 inch. WEO025664A Hotbar version is built in with SSD1362 driver IC; it can communicate via 6800/8080 8-bit parallel, I2C, 3-Wire and 4-Wire SPI interface; it supports 4 bits grayscale image. The supply voltage for logic of WEO025664A is 3V supply, 1/64 duty cycle, display with 50% check board current is 15mA@ 12Vcc (typical value). This OLED module can be operating at temperatures from -40°C to +80°C; its storage temperatures range from -40°C to +85°C.

WEO025664A-Hotbar version is directly solder flex tail for super-thin profile. This COG structure OLED module is ultra thin 1.61 mm; lightweight and low power consumption. It is suitable for smart home application, meter device, personal care appliance, health device, etc. Winstar provides ZIF FPC and Hotbar versions for customers to choose the suitable module for your application.

WEO025664A-Hotbar	Dimension
Dot Matrix	256 x 64 Dots
Module dimension	60.5 x 19.0 x 1.61 mm
Active Area	51.18 x 12.78 mm
Pixel Size	0.18 x 0.18 mm
Pixel Pitch	0.2 x 0.2 mm
Display Mode	Passive Matrix
Display Color	White/Yellow
Drive Duty	1/64 Duty
Gray Scale	4 Bits
IC	SSD1362
Interface	3-Wire and 4-Wire SPI, I2C, 6800, 8080
Size	2.08 inch

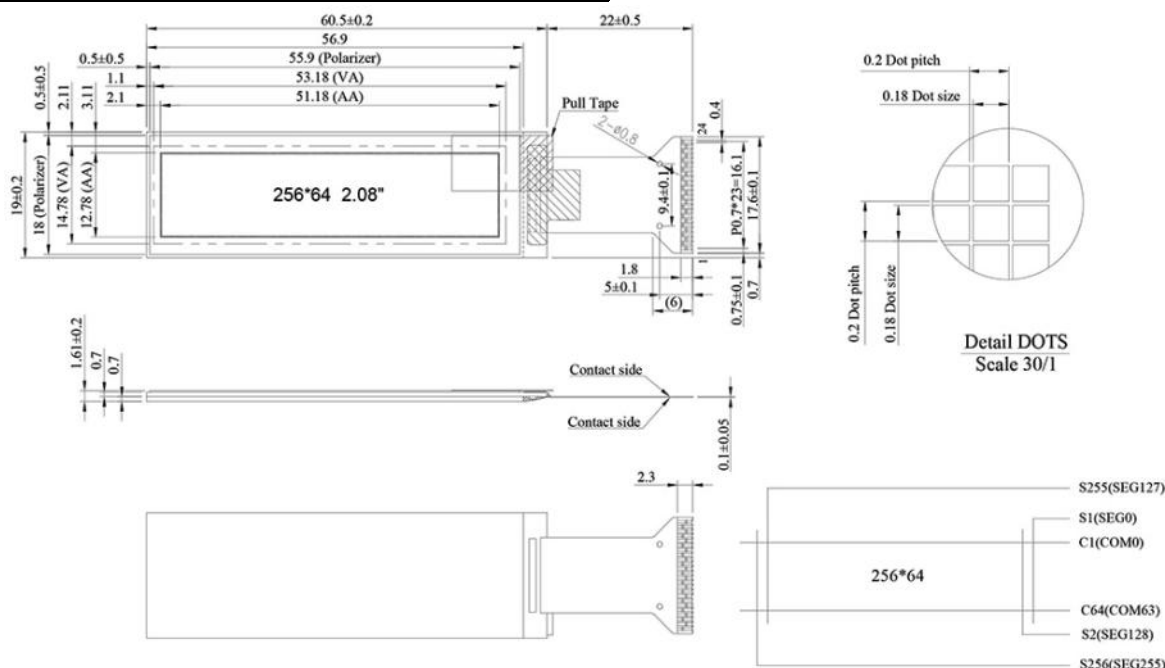

2.08" COG OLED WEA025664A with PCB Board

WEA025664A is a graphic COG with PCB OLED display model, which is made of 256x64 pixels, diagonal size 2.08 inch. WEA025664A is built in with SSD1362 driver IC; it supports 4-Wire SPI interface, 4 bits grayscale image, 1/64 duty cycle. WEA025664A model is having PCB outline size 70.0 x 22.0 mm with mounting holes on board and 7x1 metal pins on module.

WEA025664A is supported by 3V ~5V, within DC-DC conversion circuit, display with 50% check board current is 90mA@3Vdd (typical value), 1/64 duty cycle. This OLED module can be operating at temperatures from -40°C to +80°C; its storage temperatures range from -40°C to +85°C.

WEA025664A	Dimension
Dot Matrix	256 x 64 Dots
Module dimension	70.0 x 22.0 x 1.71 mm
Active Area	51.18 x 12.78 mm
Pixel Size	0.18 x 0.18 mm
Pixel Pitch	0.20 x 0.20 mm
Display Mode	Passive Matrix
Display Color	White/Yellow
Drive Duty	1/64 Duty
Gray Scale	4 Bits
IC	SSD1362
Interface	SPI
Size	2.08 inch

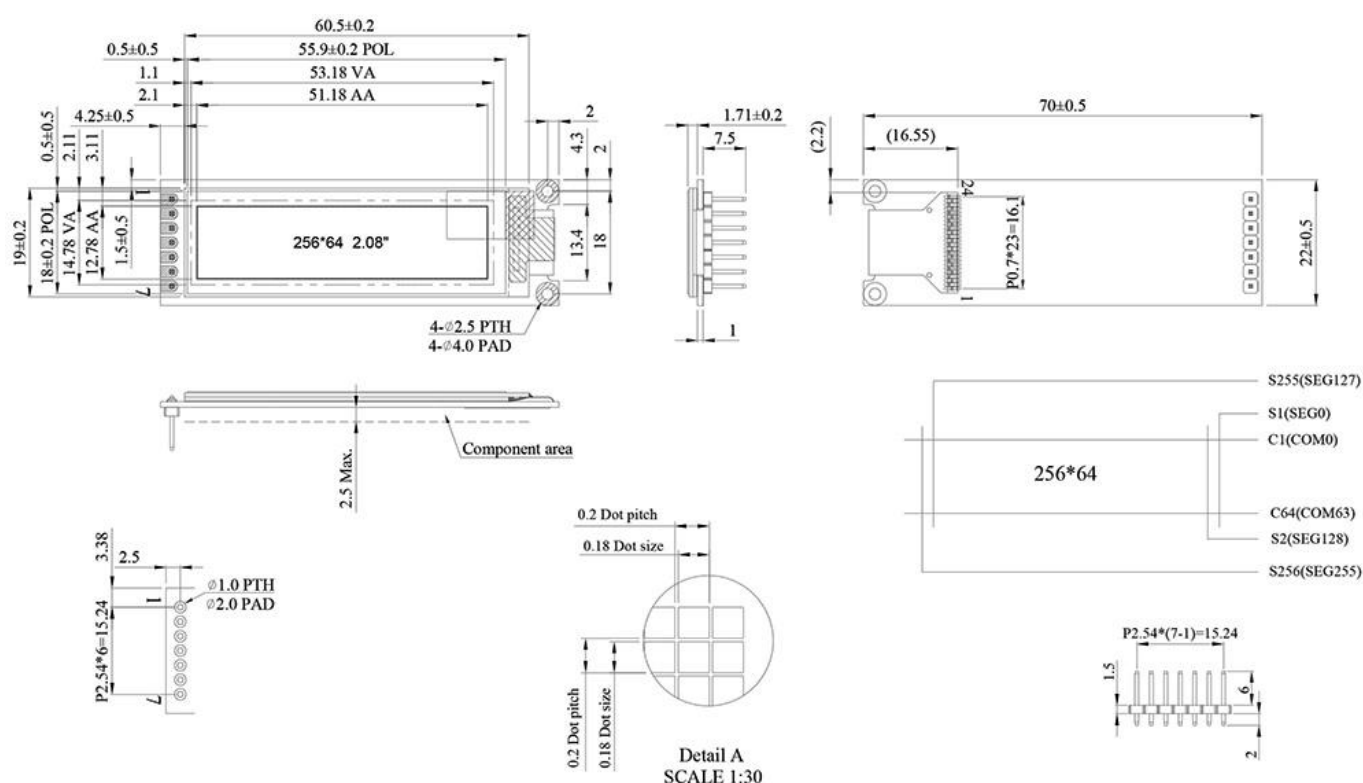

Winstar Bar TFT Selection Guide (1)

The mainstream aspect ratio of the TFT LCD panel in the market is 4:3 or 16:9 aspect ratio. But for some applications, bar type shape of display panel would be better than the current mainstream 4:3 or 16:9, for example, server system, POS system, dynamic information displays, audio system, advertising display, industrial equipment, automation application and control panel for conference solution.

Winstar already released a series of Bar Type TFT LCD display in a row; such as WF39B, WF46A, WF52A, WF52Q model. These bar type TFT displays are perfect for the above mentioned applications. In order to meet with customers requirement especially for industrial applications, we develop more derivative solutions from these Bar type TFT, e.g. with screw hole on module, with touch panel, high brightness, with controller board. Here are some selection guides for customers to choose suitable Winstar Bar TFT for your product.

1.) Choosing the right interface fit for your product.

Winstar Bar Type TFT module has several kinds of interfaces, RBG, 8080 family MCU, and for HDMI signal interface.

RGB Interface Bar TFT:

- ▶ 3.9inch: WF39BTLASDNN0,WF39BTLASDNGA,WF39BTLASDNT0,WF39BTZASDNN0,WF39BSQASDNN0.
- ▶ 4.6 inch: WF46ATIATDNNNA
- ▶ 5.2 inch: WF52ATLASDNN0,WF52ATLASDNT0,WF52ATLASDNG0,WF52ATZASDNN0,WF52ATZASDNG0,WF52ASZASDNN0,WF52ASZASDNG0,WF52ASLASDNN0,WF52ASLASDNG0.

MCU Interface Bar TFT:

- ▶ 3.9 inch: WF39QTIBSDBN0, WF39QTIBSDBG0
- ▶ 5.2 inch: WF52QSZBSDBN0, WF52QTLBSDBN0, WF52QTLBSDBG0, WF52QTZBSDBN0

For HDMI Signal Interface Bar TFT:

- ▶ 5.2 inch: WF52ASZFSDHGV



▶ [Link to Winstar Bar TFT Product web page](#)

Winstar Bar TFT Selection Guide (2)

2.) Do you require a Touch Panel on your product?

There are two kinds of touch screen solutions for Winstar Bar Type TFT, one is Projected capacitive Touch Panel (PCAP), the other is Resistive Touch Panel (RTP).

With PCAP module P/N:

- ▶ 3.9 inch: WF39BTLASDNGA
- ▶ 5.2 inch: WF52ATLASDNG0, WF52ATZASDNG0, WF52ASZASDNG0, WF52ASLASDNG0, WF52QTLBSDBG0

With RTP module P/N:

- ▶ 3.9 inch: WF39BTLASDNT0
- ▶ 5.2 inch: WF52ATLASDNT0

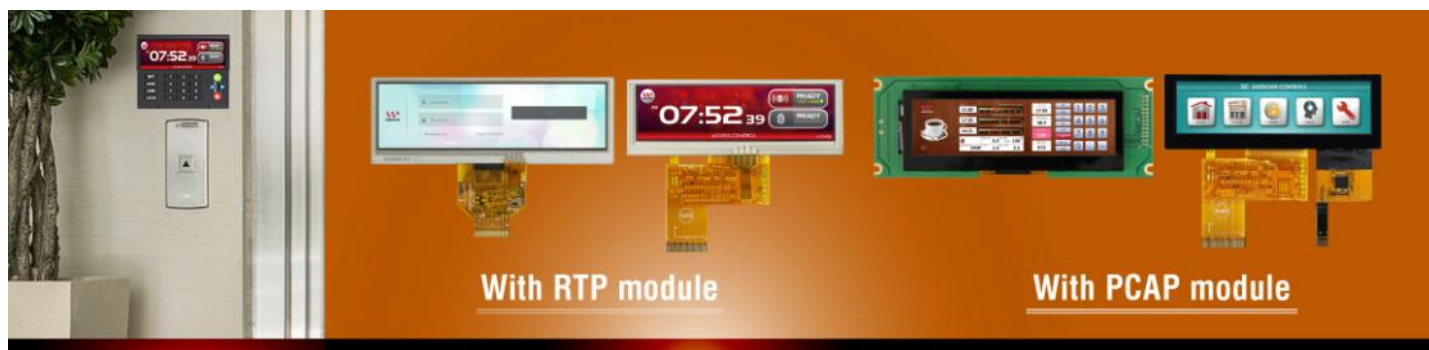

3.) Do you need high brightness for your product?

Winstar Bar TFT high brightness items are featured with brightness up from 700 nits to 1100 nits. Winstar High Brightness TFT Displays are very suitable for outdoor applications.

High Brightness Bar TFT module P/N:

- ▶ 3.9 inch: WF39BSQASDNN0
- ▶ 5.2 inch: WF52ASZASDNN0, WF52ASZASDNG0, WF52ASLASDNG0, WF52ASLASDNN0, WF52QSZBSDBN0.



▶ [Link to Winstar Bar TFT Product web page](#)

Winstar Bar TFT Selection Guide (3)

4.) Do you need wider viewing angle for your product?

O-Film technology is a good solution to improve the viewing angle of TFT module. Here are the available Winstar Bar TFT modules with O-Film Technology:

O-Film Bar TFT module P/N:

▶ 3.9 inch: WF39BTZASDNN0

▶ 5.2 inch: WF52ATZASDNN0, WF52ATZASDNG0, WF52ASZASDNN0, WF52ASZASDNG0, WF52QSZBSDBN0, WF52QTZBSDBN0



▶ [Link to Winstar Bar TFT Product web page](#)